

OPERATION MANUAL

OSCILLOSCOPE

MODEL 5520GR

KIKUSUI ELECTRONIC CORPORATION

804112

# Power Requirements of this Product

Power requirements of this product have been changed and the relevant sections of the Operation Manual should be revised accordingly.

(Revision should be applied to items indicated by a check mark )

Input voltage

The input voltage of this product is \_\_\_\_\_ VAC,  
and the voltage range is \_\_\_\_\_ to \_\_\_\_\_ VAC. Use the product within this range only.

Input fuse

The rating of this product's input fuse is \_\_\_\_\_ A, \_\_\_\_\_ VAC, and \_\_\_\_\_.

### WARNING

- To avoid electrical shock, always disconnect the AC power cable or turn off the switch on the switchboard before attempting to check or replace the fuse.
- Use a fuse element having a shape, rating, and characteristics suitable for this product. The use of a fuse with a different rating or one that short circuits the fuse holder may result in fire, electric shock, or irreparable damage.

AC power cable

The product is provided with AC power cables described below. If the cable has no power plug, attach a power plug or crimp-style terminals to the cable in accordance with the wire colors specified in the drawing.

### WARNING

- The attachment of a power plug or crimp-style terminals must be carried out by qualified personnel.



## TABLE OF CONTENTS

	<u>PAGE</u>
1. GENERAL .....	1
1.1 Description .....	1
1.2 Features .....	1
2. SPECIFICATIONS .....	4
3. OPERATING INSTRUCTIONS .....	12
3.1 Explanation of Front Panel .....	12
3.2 Explanation of Rear Panel .....	19
3.3 Explanation of Bottom Panel .....	20
3.4 Precautions for Operation .....	23
3.5 Line Voltage Conversion .....	24
4. OPERATING PROCEDURE .....	26
4.1 Preparative Procedure .....	26
4.2 Dual-trace Operation .....	29
4.3 X-Y Operation .....	30
4.4 Intensity Modulation .....	31
4.5 Sweep Magnification .....	32
4.6 Types of Trigger Modes .....	33
5. MEASURING METHODS .....	37
5.1 Connection Method of Input Signal .....	37
5.2 Voltage Measurement .....	41
5.3 Current Measurement .....	42
5.4 Measurement of Time Interval .....	43
5.5 Frequency Measurement .....	44
5.6 Measurement of Phase Difference .....	45
5.7 Measurement of Pulse Waveform Characteristics .....	47

804113

	<u>PAGE</u>
6. CALIBRATION .....	51
6.1 General .....	51
6.2 Check and Adjustment of DC Power Supply ....	51
6.3 Adjustment of Vertical Axis .....	56
6.4 Adjustment of Time Axis .....	60
6.5 Adjustment of Horizontal Axis (X-axis) .....	62
6.6 Calibration of Probe .....	63
* Use of Illuminatable External Graticule ....	65
Block diagram .....	66
Schematic diagram	

## 1. GENERAL

### 1.1 Description

Kikusui Model 5520GR Oscilloscope is a trigger-synchronized dual-trace portable oscilloscope with a 133-mm (5.24 in.) round high-brightness low-distortion and internal-printed graticule cathode-ray tube. Its sensitivity is 1 mV/DIV ( $5 \times \text{MAG}$ ), bandwidth 20 MHz, and sweep speed 40 nsec/DIV (under  $5 \times \text{MAG}$  mode). It can be well used for research and development of various electronic devices as well as for production and maintenance.

### 1.2 Features

Outstanding features of the 5520GR are as follows:

- o CRT with internal graticule:

A cathode-ray tube with internal graticule, which enables accurate waveform observation free from parallax, is employed. Photographing of graticule scale lines also is possible by installing the external graticule which is supplied accompanying the oscilloscope.

- o Acceleration voltage 2 kV:

The acceleration voltage is as high as 2 kV, enabling very bright and sharp images.

- o High-brightness CRT:

The 5520GR employs a CRT of an excellent beam transmission factor, providing a sufficient trace brightness even at the highest sweep speed.

- o CH1 SIGNAL OUT terminal:

This terminal on the rear panel provides the amplified CH1 signal. With this provision, the oscilloscope can be used as a wide-range high-sensitivity amplifier, and be fed to a frequency counter, etc.

- o High voltage supply stabilized with DC-DC converter:

The high voltage supply is stabilized with a DC-DC converter, ensuring reliable measurement less affected by AC line voltage variation, etc.

- o Rotation coil for trace leveling:

The 5520GR employs a rotation coil to adjust (rotate) the base line for leveling when it has become slanted by terrestrial magnetism.

- o Camera-mount bezel and graticule illumination:

The CRT bezel has a camera-mount which enables to install a camera in one-touch operation.

- o Automatic CHOP/ALT switching:

The sweep mode is automatically switched between CHOP mode and ALT mode in conformity with the sweep speed (linked to the TIME/DIV switch), thereby preventing troublesome manual switching between the two modes when in the dual-trace operation.

- o Simple trigger selection method:

Simply by setting the trigger input selector in the internal trigger state, a trigger input signal which is suitable for the displayed waveform is automatically selected being linked to switching of the vertical operation mode selector.

- o Automatic TV·V/TV·H synchronization:

The TV synchronization separator circuit is automatically switched between TV·V and TV·H in conformity with the sweep time, being linked to the TIME/DIV switch.

- o X-Y mode selectable by one-touch action:

Simply by switching the operation of the vertical axis, the oscilloscope can be converted into an X-Y scope with CH1 input for X-axis and CH2 input for Y-axis.

- o Maximum sweep time 40 nsec/DIV (with 5 × MAG):

The sweep time can be magnified by 5 times. By magnifying the sweep time of 0.2 μsec/DIV by 5 times, a sweep time as fast as 40 nsec/DIV can be attained.

- o Sweep stop mode:

For observation of a very low frequency signal or H and L levels of a digital signal, the sweep can be stopped at an arbitrary position.

- o Single sweep function (one-shot sweep function):

With this single sweep function, even non-repetitive transiential signal waveforms also can be photographed.

## 2. SPECIFICATIONS

### Cathode-ray Tube

Item	Spec	Remarks
Type	Round, 133 mm	(5.24 in.)
Fluorescent screen	B31	Green
Acceleration voltage	Approx. 2 kV	
Area (graticule)	10 DIV × 8 DIV	1 DIV = 10 mm (0.39 in.)
Unblanking	DC-coupling	
Graticule	Internal-printed graticule	No illuminated
External graticule illumination	Possible by installing the external graticule for photographing.	External graticule accessory

### Vertical Axis

Item	Spec.	Remarks
Sensitivity	5 mV/DIV ~ 10 V/DIV, 1 mV ~ 2 V/DIV (when 5 × MAG)	1-2-5 sequence 11 positions
Sensitivity accuracy	Better than ±5%	CAL'D position
Continuously-variable sensitivity adjustment	Continuously-variable between adjoining ranges	
Frequency response	DC: DC ~ 20 MHz (10 MHz when 5 × MAG) AC: 2 Hz ~ 20 MHz (10 MHz when 5 × MAG)	50 kHz, 8 DIV reference, within -3 dB



Item	Spec.		Remarks
Rise time	Approx. 17.5 nsec (Approx. 35 nsec when 5 × MAG)		
Input impedance	1 MΩ ±2%, 30 pF ±2 pF		
Input terminals	BNC receptacles		
Maximum allowable input voltage	600 Vp-p, for 1 minute. (400 Vp-p for 5, 10, 20, 50 mV/DIV and 0.1, 0.2 V/DIV ranges)		DC + AC peak, frequency not higher than 1 kHz.
Input coupling	AC, DC, or GND		
Base line shift caused by range selection	±0.5 DIV ( 2.0 DIV when 5 × MAG)		Including shift caused by distur- bance of DC balance
Linearity	Vertical contraction or extension is within ±0.1 DIV when signal with 4 DIV amplitude in screen center is moved to upper or lower limit of effec- tive screen area.		Including linearity of CRT
Operation modes of vertical axis	CH1	Single-channel mode	
	CH2	Single-channel mode	
	DUAL	CHOP mode	0.5 sec ~ 1 msec
		ALT mode (linked to TIME/DIV switch)	0.5 msec ~ 0.2 μsec
Chop frequency	Approx. 200 kHz		

Item	Spec.	Remarks
CH1 signal output voltage	Approx. 10 mV/DIV into 50Ω load Approx. 20 mV/DIV into no load 20 MHz, -3 dB	At 50 terminated

### Triggering

Item	Spec.		Remarks
Trigger modes	AUTO	When trigger signal is removed, sweep is in AUTO (FREE RUN) mode	Satisfies the trigger sensitivity specification for repetitive signals of 50 Hz or over.
	NORM	When trigger signal is removed, base line is blanked out and sweep is in STANDBY state.	Satisfies the trigger sensitivity specification.
	SINGLE	When trigger signal is applied, sweep runs only once; when RESET button is pressed, SWEEP IS IN READY state. When in READY state or sweeping state, READY lamp lights.	Satisfies the trigger sensitivity specification.

801120

Item	Spec.		Remarks
Trigger source	INT	Trigger source is selected being linked to VERT MODE switch. When in dual-trace operation, CH1 signal is used as trigger signal source.  (When DUAL and CH2 buttons are pressed at the same time, CH2 signal is used as trigger signal.	
	EXT	An input signal applied to EXT TRIG terminal is used as trigger signal.	
Internal trigger sensitivity	DC	DC ~ 10 MHz 0.5 DIV DC ~ 20 MHz 1.0 DIV	
	AC	2Hz ~ 10 MHz 0.5 DIV 2Hz ~ 20 MHz 1.0 DIV	
	TV	Video signal sensitivity 1.0 DIV	
External trigger sensitivity	DC	DC ~ 20 MHz 0.5 V	
	AC	2Hz ~ 20 MHz 0.5 V	
	TV	Video signal 1.0 V	
Polarity		"+" and "-"	
Coupling		AC and DC	
EXT TRIG input impedance		Approx. 1 M $\Omega$ , 30 pF or less	
Maximum allowable input impedance		100 Vp-p (DC + AC peak)	Frequency not higher than 1 kHz
EXT TRIG terminal		BNC terminals	

Horizontal Axis

Item	Spec.	Remarks
Sweep time	0.2 $\mu$ sec ~ 0.5 sec/DIV	1, 2, 5, 20 ranges
Continuously variable range of sweep time	Continuously variable to 2.5 times or over of TIME/DIV switch indicated value	
Sweep time accuracy	Better than $\pm 5\%$ of panel indicated value with VARIABLE knob set in CAL'D position	
Sweep magnification	5 times	
Sweep magnification accuracy	Within $\pm 5\%$	
Position shift caused by sweep magnification	Less than 1 DIV at CRT screen center	
Sweep stop	Sweep stops and trace becomes a spot.	
X-Y mode	CH1 for X (horizontal) CH2 for Y (vertical)	
Sensitivity	Same as that of CH1 of vertical axis.	
Frequency response	DC: DC ~ 1 MHz AC: 2 Hz ~ 1 MHz	50 kHz, 8 DIV reference, within -3 dB
Input impedance	Same as that of CH1 of vertical axis	

Item	Spec.	Remarks
Maximum allowable input voltage	Same as that of CH1 of vertical axis	
X-Y phase difference	Within 3° at 50 kHz	

Z Axis

Item	Spec.	Remarks
Coupling	DC-coupling	
Sensitivity	Intensity modulation discernible with 3 Vp-p or over	
Frequency response	DC ~ 5 MHz	
Polarity	Darkened with positive-going signal, and vice versa.	
Input resistance	Approx. 10 k $\Omega$	
Input terminals	Binding post terminal	Rear panel

### Calibration Voltage

Item	Spec.	Remarks
Waveform	Square wave, positive-going	
Output voltage	1 V <sub>p-p</sub> , ±3%	
Frequency	1 kHz ±25%	
Duty ratio	Within 45 : 55	
Output terminal	Chip terminal	

### Power Requirements

Item	Spec	Remarks
AC line voltage	100, 110, 120, 220, 230, or 240 V. (Within ±10% of each nominal voltage)	Selectable with connector and a pin on the voltage selector board
Frequency	50 ~ 60 Hz	
Power consump- tion	Approx. 40 VA	

### Mechanical Specification

Item	Spec.	Remarks
Overall dimensions	244 W × 184 H × 370 D mm (9.61W × 7.24H × 14.57D in.)	
	250 W × 210 H × 435 D mm (9.84W × 8.27H × 16.73D in.)	Maximum dimensions
Weight	Approx. 8 kg (17.6 lb.)	

807122

Ambient Conditions (Temperature and Humidity)

Item	Spec.	Remarks
Specification range	5°C ~ 35°C (41°F ~ 95°F), 85% or less	Temperature range for satisfying the specifi- cation performances
Maximum operatable range	0 °C ~ 40°C (32°F ~ 104°F), 90% or less	Temperature range within which the oscilloscope is operatable

Accessories

Type 960 BNC Probe (10:1, 1:1) .....	2
Type 942A Terminal Adaptor .....	2
External graticule .....	1
(See page 65. How to use of the "External graticule".)	
Operation Manual .....	1

11118  
H271A08

### 3. OPERATING INSTRUCTIONS

#### 3.1 Explanation of Front Panel (See Figure 1)









No.	Panel mark	Description
①	EXT GRAT ILLUM (POWER OFF)	Graticule illumination control knob with POWER switch. Extremely counterclockwise position is POWER OFF. As turned clockwise, POWER is turned ON and illumination increases.
②	INTEN	Trace intensity control
③	FOCUS	Focus control knob. So adjust this knob that the trace displayed on the screen becomes sharpest.
④	CAL 1 Vp-p	Output terminal which provides a calibration signal used for oscilloscope sensitivity adjustment and probe calibration. The signal a positive square wave of 1 Vp-p, approx. 1 kHz.
⑤		Internal-printed graticule
⑥		Graticule with adjustable illumination
⑦		Bezel for camera mount
⑧	↑ POSITION  PULL 5×MAG	For vertical positioning of CH2 (or Y-axis). The trace moves upward as this knob is turned clockwise, and vice versa. When this knob is pulled out, vertical sensitivity becomes 1/5 of value indicated on panel, e.g. 5 mV/DIV range becomes 1 mV/DIV and 10 V/DIV becomes 2 V/DIV. (When in the 5 × MAG state, frequency response becomes DC - 10 MHz.)





No.	Panel mark	Description
<p>⑨</p> <p>⑩</p> <p>⑪</p> <p>⑫</p>	<p>MODE</p> <p>CH1 <input type="checkbox"/></p> <p>DUAL <input type="checkbox"/></p> <p>X-Y <input type="checkbox"/></p> <p>CH2 <input type="checkbox"/></p> <p>CH2 TRIG (WITH CH2 )</p>	<p>Pushbuttons (4-gang) for operation mode switching of CH1 and CH2 amplifiers and for trigger signal source selection.</p> <p>CH1: Single-channel operation with CH1 vertical amplifier alone. CH1 input signal is used as trigger signal.</p> <p>CH2: Single-channel operation with CH2 vertical amplifier alone. The CH2 input signal is used as trigger signal.</p> <p>DUAL: Dual-channel operation with CH1 and CH2 vertical amplifiers, in the CHOP or ALT mode. CH1 input signal is used as trigger signal. If DUAL button ⑪ and CH2 button ⑨ are depressed at the same time, CH2 signal is used as trigger signal.</p> <p>The sweep mode is automatically switched between CHOP and ALT, being linked to TIME/DIV switch ⑫.</p> <p>X-Y: X-Y operation with CH1 as X-axis (horizontal) and CH2 as Y-axis (vertical).</p>
<p>⑬</p>	<p>↑ POSITION</p> <p>PULL 5xMAG</p>	<p>Vertical positioning of CH1. Trace moves upward as this knob is turned clockwise, and vice versa. Function of 5 x MAG is the same with that of ⑧.</p>

804127

No.	Panel mark	Description
⑭	VOLTS/DIV	Sensitivity selector switch of CH1 (or X-axis) for 5 mV/DIV ~ 10 V/DIV in 11 ranges. When POSITION knob ⑬ is pulled out, the sensitivities are multiplied by 5 and become 1 mV/DIV ~ 2 V/DIV.
⑮	VAR ← ▼ CAL'D	Continuously-variable adjustment of vertical sensitivity of CH1 (or X-axis), covering between ranges selected by VOLTS/DIV switch ⑭.  (At the ▼ CAL'D position, sensitivity is calibrated to the value indicated by VOLTS/DIV switch ⑭.)
⑯	VAR ← ▼ CAL'D	Continuously-variable adjustment of vertical sensitivity of CH2 (or Y-axis), covering between ranges selected by VOLTS/DIV switch ⑰.  (At the ▼ CAL'D position, sensitivity is calibrated to the value indicated by VOLTS/DIV switch ⑰.)
⑰	VOLTS/DIV	Sensitivity selector switch of CH2 (or Y-axis) for 5 mV/DIV ~ 10 V/DIV in 11 ranges. When POSITION knob ⑧ is pulled out, the sensitivities are multiplied by 5.
⑱	CH1 (X) INPUT	Input terminal for vertical axis CH1 or X-axis (horizontal axis) when in X-Y operation. Signal can be applied with probe (accessory) or BNC connector.

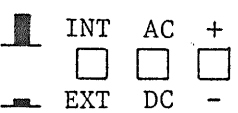
No.	Panel mark	Description
①⑨	 AC  DC	Input-coupling selector switch of CH1 (or X-axis). The popped up state (  ) is for AC-coupling for measurement of AC components alone; the depressed state (  ) is for observation of signal including DC component.
②⑩	 GND	Pushbutton switch for grounding the input of amplifier of CH1 (or X-axis). When this switch is depressed (grounded state), input terminal ①⑧ becomes open. This switch is used for checking of 0 level, etc.
②①	CH2 (Y) INPUT	Input terminal for vertical axis CH2 or Y-axis (vertical axis) when in X-Y operation.
②②	 AC  DC	Input-coupling selector switch of CH2 (or Y-axis). The function is the same as that of switch ①⑨.
②③	 GND	Pushbutton switch for grounding the input of amplifier of CH2 (or Y-axis). The function is the same as that of switch ②⑩.
②④	EXT TRIG IN	Input terminal for external trigger signal. When the TRIGGERING switch ③⑩ is set in the  EXT state, the sweep is triggered by the signal applied to this terminal.

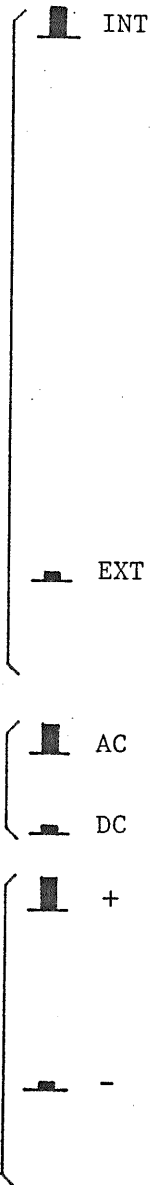
No.	Panel mark	Description
②⑤	TIME/DIV	<p>Horizontal sweep time selector switch for 0.5 sec/DIV ~ 0.2 <math>\mu</math>sec/DIV in 20 ranges, covering DC to high frequency.</p> <p>The extremely counterclockwise position is for SWEEP STOP for observation of very low frequency signal or H and L levels of a digital signal.</p> <p>(Note: When in SWEEP STOP, reduce the intensity lest CRT screen should be burned.)</p>
②⑥	VAR ← CAL'D	<p>Continuously-variable adjustment of sweep time, covering between ranges selected by TIME/DIV switch ②⑤.</p> <p>When this knob is set in the CAL'D position, the sweep time is calibrated at the value indicated by the TIME/DIV switch.</p>
②⑦	LEVEL - ← 0 → +	<p>Trigger level control for displaying stationary waveform and adjusting the start point of sweep. The trigger level rises as this knob is turned toward → + and it falls as the knob is turned toward - ←.</p>
②⑧ ②⑨ ③⑩	TRIGGERING 	<p>Triggering switch circuit consisting of trigger source selector switch ③⑩, input coupling selector switch ②⑨, and slope selector switch ②⑧. The functions of these switches are as follows:</p>

No.	Panel mark	Description
	 <p>Panel marks include: INT, EXT, AC, DC, +, -</p>	<p>Trigger source is internal and switched being linked to the vertical MODE selector switch as follows:</p> <p>CH1: Input signal of CH1 is used as trigger signal.</p> <p>Dual: Input signal of CH1 is used as trigger signal automatically, and see page 6 where Item "Trigger source"</p> <p>X-Y:</p> <p>CH2: Input signal of CH2 is used as trigger signal.</p> <p>Trigger source is external and the signal applied through the EXT TRIG IN terminal (24) is used as trigger signal.</p> <p>Trigger signal is applied through AC-coupling.</p> <p>Trigger signal is applied through DC-coupling.</p> <p>Triggering is effected when trigger signal crosses the trigger level from negative side to positive side.</p> <p>Triggering is effected when trigger signal crosses the trigger level from positive side to negative side.</p>
<p>(31)</p>	 <p>Panel mark: POSITION, PULL 5xMAG</p>	<p>Horizontal positioning and 5 times magnification of sweep. The displayed waveform moves rightward as this knob is turned clockwise, and vice versa. When this knob is pulled out, the sweep speed is multiplied by a factor of 5, thereby magnifying the horizontal amplitude by 5 times, although noise increases and the frequency range becomes narrower.</p>

No.	Panel mark	Description
③② ③③ ③④	TRIG MODE	<p data-bbox="657 365 1236 443">Pushbutton switches for selection of trigger mode.</p> <p data-bbox="657 499 1332 857"> <b>AUTO:</b> When trigger signal is removed, trace is not blanked out, thereby providing a convenient means of confirming existence/absence of input signal and checking of zero level. This mode is applicable to observation of repetitive signals of 50 Hz or over.         </p> <p data-bbox="657 896 1332 1108"> <b>NORM:</b> When trigger signal is removed, trace is blanked out and sweep is in STANDBY state. Used primarily for observation of signals lower than 50 Hz.         </p> <p data-bbox="657 1142 1364 1556"> <b>BOTH-IN TV:</b> When both AUTO ③② and NORM ③③ buttons are pressed-in, TV sync separator circuit is connected to the trigger circuit. Being linked to TIME/DIV switch ②⑤, triggering is done with TV·V or TV·H sync signal. When trigger signal is not applied, sweep runs in AUTO (FREE RUN) mode.         </p> <p data-bbox="657 1590 1380 1668"> <b>SINGLE:</b> For single sweep operation that the sweep runs only one when trigger         </p> <p data-bbox="657 1691 1380 1724"> <b>PUSH TO</b> signal is applied. When this button         </p> <p data-bbox="657 1736 1380 1803"> <b>RESET:</b> is pressed again, the sweep is reset ready for next one shot of sweep.         </p>

No.	Panel mark	Description
③⑤	READY	This LED lights when sweep is in the ready state in SINGLE mode ③④ .
③⑥	TRACE ROTATION	Semi-fixed potentiometer for adjustment of horizontal slanting of base trace line caused by terrestrial magnetism, etc.

### 3.2 Explanation of Rear Panel

No.	Panel mark	Description
③⑦	—	AC power cord of the oscilloscope
③⑧	—	Studs for using the oscilloscope in a vertical attitude. Also used as AC power cord take-up posts.
③⑨	Z-AXIS INPUT	Input terminal (binding post) for external intensity modulation signal. Used when intensity is controlled with an external signal, when intensity markers are displayed, etc. When not in use, this terminal must be connected to the GND terminal ④⑩ with the shorting bar.
④⑩		GND terminal (binding post). Spacing with respect to Z-AXIS INPUT terminal ③⑨ is 19 mm (0.75 in.).
④①	(FUSE)	Fuse holder. Fuse rating is 0.5 A for 100 V system AC line or 0.3 A for 200 V system AC line. For replacing the fuse, remove the cap by turning it counterclockwise.
④⑤	CH1 SIGNAL OUT	This output terminal provides CH1 signal which is fed to a frequency counter, etc.

### 3.3 Explanation of Bottom Panel

No.	Panel mark	Description
④②	ASTIG	Semi-fixed resistor for astigmatism control. So adjust this control in conjunction with the FOCUS control ③ that the trace is made sharpest.
④③		Studs which are used also for fixing the stand.
④④		Stand for setting the oscilloscope in a slanted attitude for ease of observation. Do not use this stand when an oscilloscope camera is used.

804134



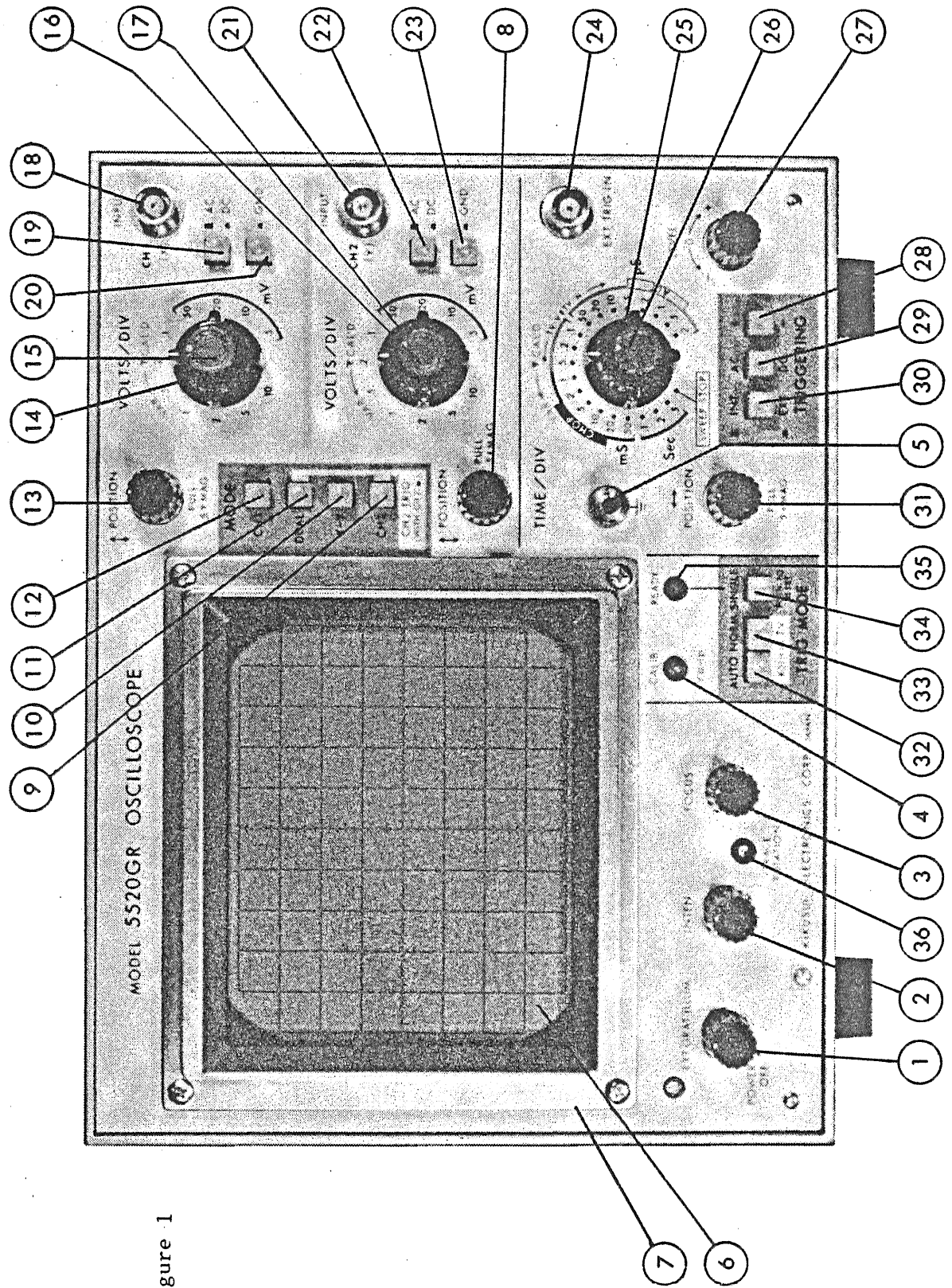

Figure 1

90047008

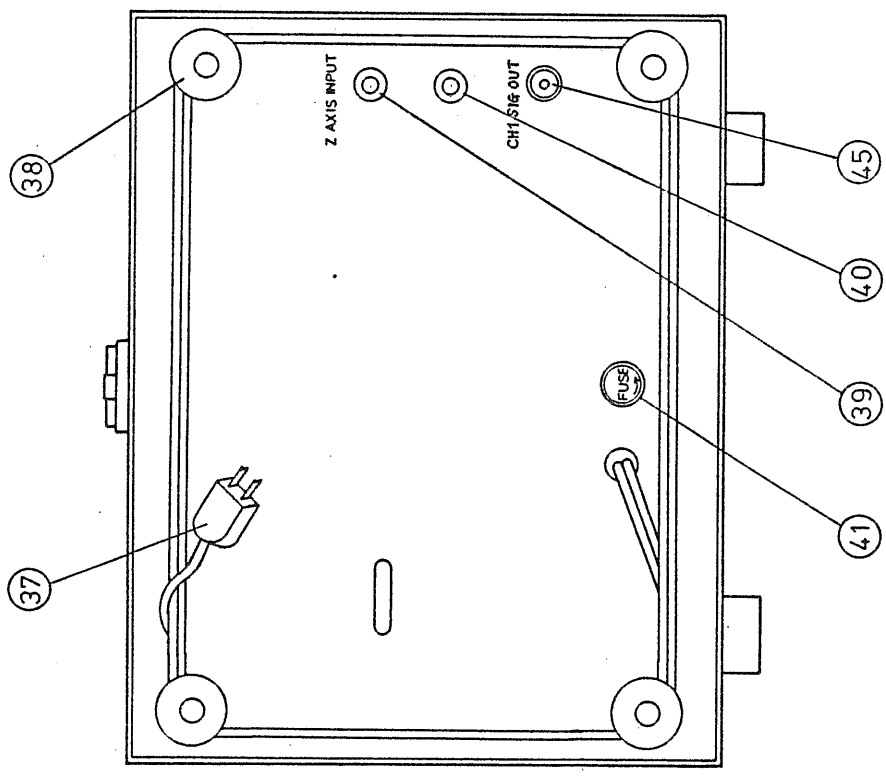

Figure 2

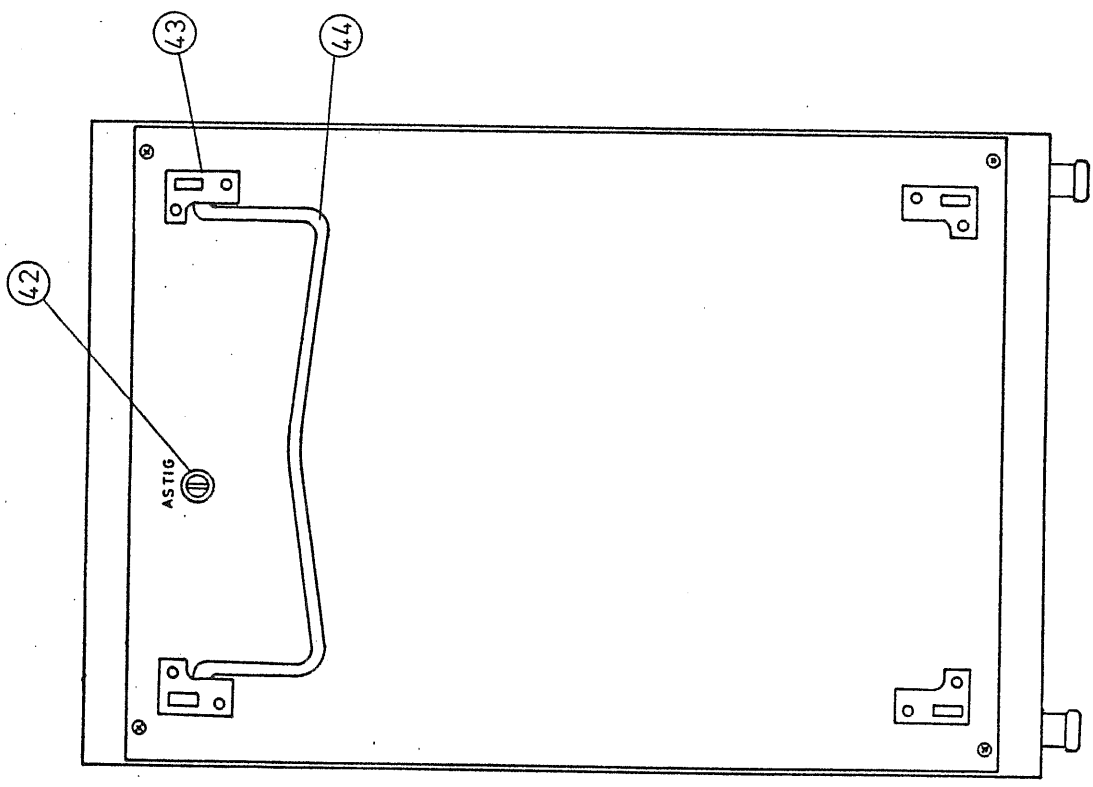

Figure 3

### 3.4 Precautions for Operation

- o Line voltage:

The oscilloscope is set for operation on a 100 V  $\pm$ 10% AC line voltage. To operate the oscilloscope on other AC line voltage, it must be modified as explained in Section 3.5 "AC Line Voltage Conversion." Note that the oscilloscope will not operate properly or may be damaged if it is operated on a wrong AC line voltage.

- o Ambient temperature:

The ambient temperature range for operatable of the oscilloscope is 0°C ~ 40°C (32°F ~ 104°F). See page 11.

- o Environments:

The oscilloscope must not be operated or stored in high temperature, high humidity atmosphere for a long time since such will cause troubles or shorten the instrument life.

If the oscilloscope is operated in a strong electric or magnetic field, the displayed waveform may be distorted.

- o Intensity of CRT beam:

Do not make the CRT image excessively bright and do not leave the spot stationary for a long period, lest the CRT screen should be "burnt" shortening its life.

804137

- o Allowable voltages of input terminals:

The maximum allowable voltages of the input terminals and probe are as shown in the below table. Note that the circuit may be damaged if a voltage larger than the allowable maximum is applied.

Terminal or probe	Allowable maximum input voltage
CH1 and CH2 input terminals 5, 10, 20, 50 mV/DIV ranges, 0.1, 0.2 V/DIV ranges Other ranges	400 V (DC + AC peak)  600 V (DC + AC peak)
Probe (960 BNC)	600 V (DC + AC peak)
EXT TRIG IN terminal	100 (DC + AC peak)
Z AXIS INPUT terminal	50 V (DC + AC peak)

Repetition frequency of AC: Not higher than 1 kHz

### 3.5 Line Voltage Conversion

As a general rule the 5520GR Oscilloscope is shipped being set for use on a 100 V AC line power. To operate the instrument on other AC line voltage, its AC power input circuit (power connector B, pin, and fuse) must be changed referring to the following table.

Nominal tap voltage	Applicable voltage range	Fuse	Connector
100 V 110 V 120 V	90 ~ 110 V 99 ~ 121 V 108 ~ 132 V	0.5 A	Connect the power connector B to the "100 V SYSTEM" pins.
220 V 230 V 240 V	198 ~ 242 V 207 ~ 253 V 216 ~ 264 V	0.3 A	Connect the power connector B to the "200 V SYSTEM" pins.

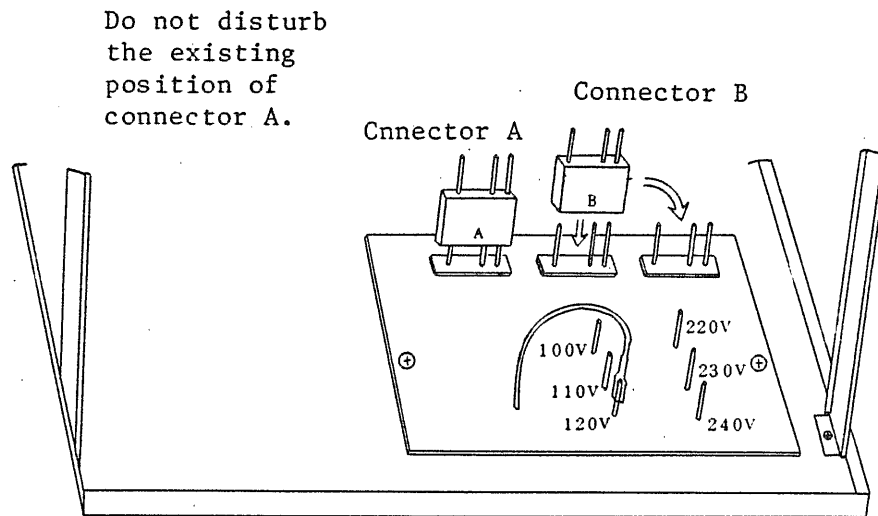

Connect the selector cord to the corresponding pin.

Figure 4

Notes:

- o Before performing AC line conversion, make it sure that the AC power cord is disconnected from the AC power line outlet.
- o Use a cord and a plug which meet the requirements of the line power to be used.
- o The line filter capacitor is not required to be changed.

#### 4. OPERATING PROCEDURE

##### 4.1 Preparative Procedure (See Figure 1)

Before turning-on the oscilloscope power, set the knobs on the front panel as shown in the following table:

Item	No.	Setting
EXT GRAT ILLUM (POWER OFF)	①	Extremely counterclockwise position (OFF position)
INTEN	②	Rightward (3 o'clock) position
FOCUS	③	Mid-position
MODE	⑨, ⑩ ⑪, ⑫	Press CH1 button ⑫.
↑ POSITION ↓	⑧ ⑬	Mid-position, depressed state
VOLTS/DIV	⑭ ⑰	0.5 V position
VARIABLE	⑮ ⑯	▼ CAL'D position
AC - DC	⑲ ⑳	■ AC position
GND	㉑ ㉒	■ GND position
TIME/DIV	㉕	0.5 msec position
VARIABLE	㉖	▼ CAL'D position
TRIGGERING	㉘ ㉙ ㉚	■ "+" position ■ AC position ■ INT position
↔ POSITION	㉛	Mid-position, depressed state
TRIG MODE	㉜, ㉝ ㉞	AUTO ㉜ position, depressed state.

After the above preparative procedure is over, connect the power cord to an AC line outlet of the correct voltage and then proceed as follows:

- 1) Turn clockwise the ILLUM knob ① from the POWER OFF position. A click sound (power-on sound) is generated and the LED lamp lights to an upper left of the knob.
- 2) At about 10 seconds after the above, a horizontal trace line will be displayed on the CRT screen. Adjust the trace to an appropriate brightness with the INTEN knob ②.

If no trace is displayed within about 20 seconds, repeat setting of each knob as indicated in the above table.

- 3) Move the trace to approximately the center of the screen by adjusting CH1 POSITION knob ⑧ and horizontal POSITION knob ⑩.
- 4) So adjust the FOCUS knob ③ that the trace becomes sharpest.
- 5) Connect the probe to CH1 INPUT terminal ⑬ and apply to the probe the signal of CALIB terminal ④.
- 6) Set the GND ⑫ switch in the popped up state (I), and so adjust the LEVEL knob ⑮ that the displayed waveform becomes stationary. A waveform as shown in Figure 5 must be displayed on the CRT screen.

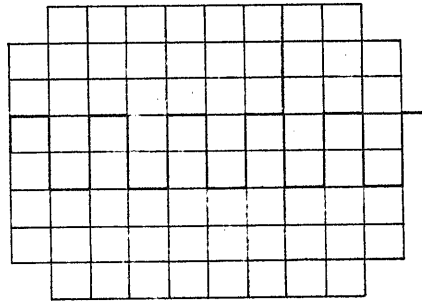

Figure 5

If the rising edges are not as shown above, adjust the phase of the probe referring to Section 6.7 "Calibration of Probe."

- 7) So adjust the VOLTS/DIV switch (14) and TIME/DIV switch (25) that an appropriate number of peaks are displayed with an appropriate amplitude.
- 8) Adjust the scale illumination at an appropriate brightness with ILLUM knob (1).

The above explanation is for the single-channel operation with CH1. The same explanation is applicable for the single-channel operation with CH2, simply by replacing "CH1" with "CH2". The dual-trace operation and general operation methods of the oscilloscope are explained in the subsequent sections.



#### 4.2 Dual-trace Operation

Change the MODE switch to the DUAL state (11) so that the other trace (CH2) also is displayed. (The trace explained in the preceding section is of CH1.) At this state of procedure, the CH1 trace is the square wave of the calibration signal and the CH2 trace is a straight line as no signal is applied to this axis yet.

Now, apply the calibration signal also to vertical INPUT terminal (21) of CH2 with the probe as is the case for CH1 and set the GND switch (23) in the popped up state (I). So adjust the vertical POSITION switches (8) and (13) that the two channels of signals are displayed as shown in Figure 6.

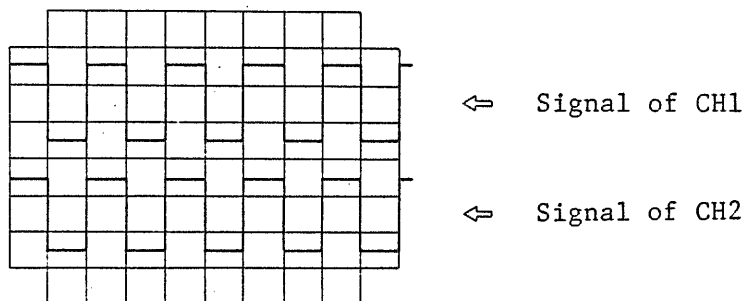

Figure 6

When in the dual-trace operation, the trigger signal source is automatically switched to the CH1 TRIG state and the sweeps are triggered by the CH1 signal alone. Therefore, if the CH2 signal is synchronized with the CH1 signal, the displayed waveforms of both channels are stationary.

This oscilloscope has eliminated the selector switch between CHOP and ALT modes for the dual-trace operation. The DUAL switch (11) alone is required to be manipulated for the dual-trace operation. The sweep mode is switched being linked to

the TIME/DIV switch (25). At the ranges the sweep speed is 1 msec/DIV or slower, switching is done in the CHOP mode; at the ranges the sweep speed is 0.5 msec/DIV or faster, switching is done in the ALT mode.

Figure 7

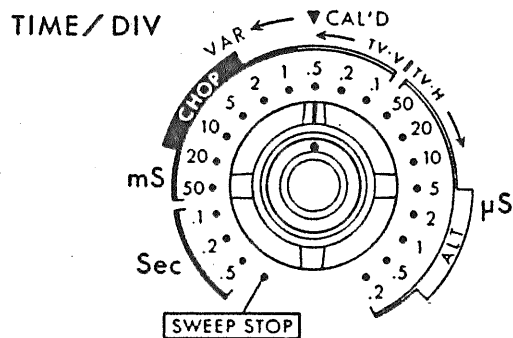

#### 4.3 X-Y Operation

Set the MODE switch in the X-Y state (10). With this simple procedure, the instrument operates as an X-Y scope with CH1 for X-axis and CH2 for Y-axis.

For the Y-axis, the CH2 operates in the same electrical performances and procedure as when in the regular operation. Regarding the X-axis, the frequency response becomes DC - 1 MHz (-3 dB) and the horizontal POSITION control (31) becomes effective for the X-axis while the CH1 POSITION control (13) becomes idle. Other electrical performances and procedure remain the same.

Apply the calibration signal to both X and Y axes, and adjust the VOLTS/DIV knobs of respective axes so that a Lissajous figure as shown in Figure 8 is displayed on the CRT screen.

80011A4

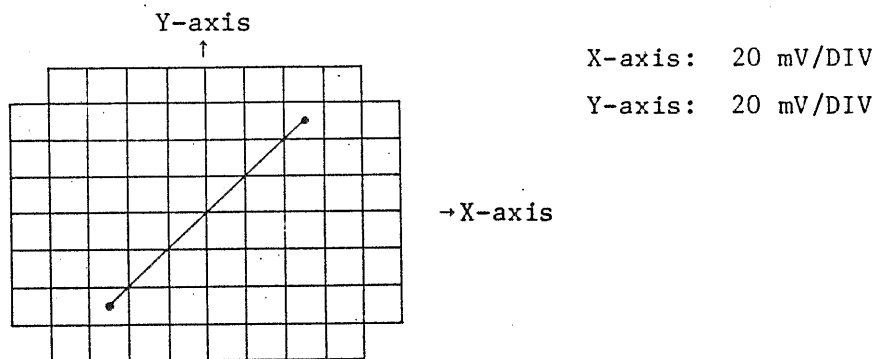

Figure 8

Note: For measurement of high frequencies with the X-Y operation, pay attention to the frequency response and phase difference between X-axis and Y-axis of the oscilloscope itself.

#### 4.4 Intensity Modulation

This mode of operation is used when controlling the trace intensity with an external signal, when displaying intensity-modulated marker signal, etc.

Disconnect the shorting bar of the external intensity modulation signal input terminal (Z-AXIS INPUT (39), see Figure 2), and apply an intensity modulation signal between Z-AXIS INPUT terminal (39) and GND terminal (40). When the intensity modulation is not used, keep the shorting bar connected.

The intensity can be controlled sufficiently with a TTL level signal. For the maximum allowable input voltage, refer to Section 3.4 "Precautions for Operation."

The intensity can be controlled also DC-wise. This feature can be utilized for remote control of trace intensity with an external DC signal.

#### 4.5 Sweep Magnification (PULL 5 × MAG)

When a small part of the input signal waveform is required to be enlarged for observation of details, a faster sweep speed may be used. However, if the part to be enlarged is apart from the start of the sweep, the part may run out of the screen. In such a case, by pulling out the HORIZONTAL POSITION knob (31) for 5 × MAG, the displayed waveform can be magnified by 5 times to right and left from the center of the screen as shown in Figure 9.

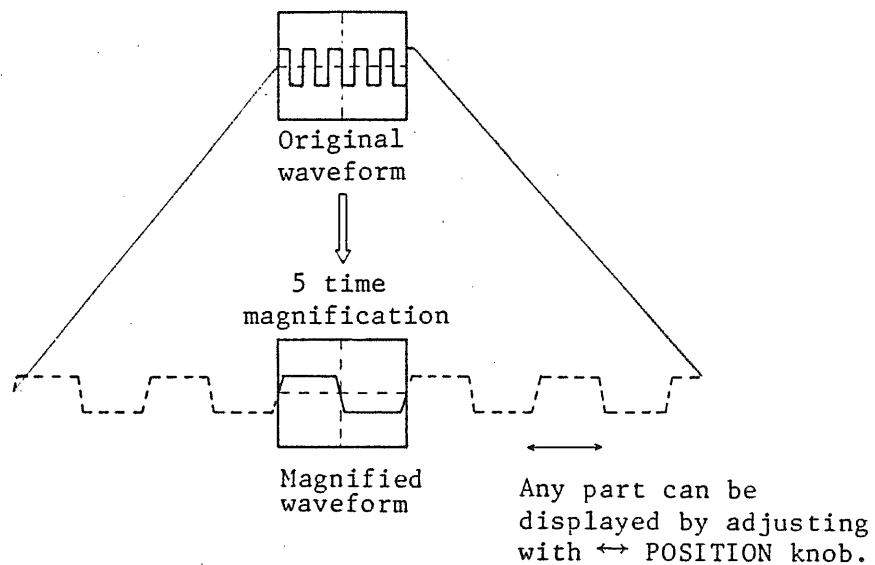

Figure 9

When magnified, the sweep time becomes as follows:

Indication of TIME/DIV switch  $\times 1/5$

The maximum sweep speed of the oscilloscope when this magnification function is used becomes as follows:

$$0.2 \mu\text{sec}/\text{DIV} \times 1/5 = 40 \text{ nsec}/\text{DIV}$$

80111A5

When the trace is magnified, the intensity becomes lower. Therefore, use of the magnification feature should be limited to the following cases:

- (1) When a part apart from the start of the sweep is required to be enlarged.
- (2) When a sweep speed faster than 0.2  $\mu\text{sec}/\text{DIV}$  is required.

#### 4.6 Types of Trigger Modes

- (1) AUTO mode:

A stable sweep operation can be obtained when the trigger input signal is higher than 50 Hz. When triggering is OFF, the sweep runs in the AUTO (FREE RUN) mode. Even at a fast sweep speed, a bright trace is displayed and the ZERO level can be easily checked. Thus, the AUTO mode is most convenient for general waveform observation.

- (2) NORM mode:

Only when a trigger input signal is applied to the trigger circuit and the trigger input signal amplitude and level are within the required ranges for driving the trigger circuit, a trigger pulse signal is produced and this signal drives the sweep circuit so that a stationary waveform is displayed on the CRT screen. This state is called "being triggered" or "triggering is effected."

When no trigger input signal is applied or the trigger level is not within the trigger input signal amplitude, the sweep circuit is in the READY state and no trace is displayed on the CRT screen. This state is called "triggering is off."

802147

When trigger is off, it may be mistaken for an incorrect setting (for example, mistaken for incorrect setting of the INTEN knob (2) or vertical POSITION knob (8) or (13). Therefore, the AUTO mode should be used except the following cases:

- (i) The repetition frequency of the trigger input signal is lower than 50 Hz.
- (ii) The waveform is required to be displayed on the screen only when the input signal (trigger signal) is applied.

(3) TV mode:

This triggering mode is used for observation of TV video signals. The TV video signal applied to the trigger input circuit is fed to a sync separation circuit for picking off the synchronization signal and this signal is used as the trigger source signal. Thus, the TV video signal is displayed very stably.

Also, being linked to the TIME/DIV knob, triggering is synchronized to the vertical sync signal (TV·V) for the ranges of 0.5 sec/DIV ~ 0.1 msec/DIV.

Set the SLOPE switch is conformity with the polarity of the sync pulses of the video signal as shown in Figure 10.

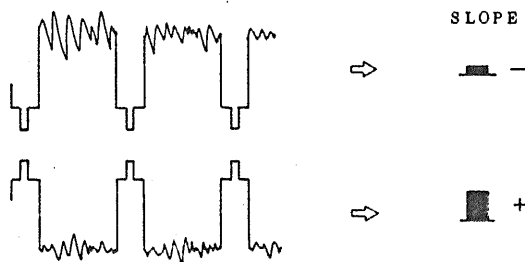

Figure 10

804148

(4) SINGLE-SWEEP mode:

When the repetition frequency or amplitude of the measured signal varies at random, the signal cannot be displayed in a stationary waveform with the regular sweep mode. For observation of such signal, it should be displayed with the SINGLE-SWEEP mode and the displayed waveform should be photographed. This sweep mode is used also for observation of a one-shot transient signal.

Observation of non-periodical signal:

- 1) Set the TRIG MODE in the NORM state.
- 2) Apply the measured signal to the vertical input terminal and set the trigger level.
- 3) Set the TRIG MODE selector in the SINGLE state (AUTO and NORM buttons pulled out).
- 4) As you press the RESET button, the sweep runs only once and a signal waveform without overlaps is displayed.

Observation of one-shot transient signal:

- 1) Set the TRIG MODE selector in the NORM state.
- 2) Apply the calibration signal to the vertical input terminal and set the trigger level for the predicted amplitude of the measured signal.
- 3) Set the TRIG MODE switch in the SINGLE state, and apply the measured signal instead of the calibration signal to the vertical input terminal.

804149

- 4) Press the RESET button, so that the sweep circuit becomes the READY state and the READY lamp lights.
- 5) As the one-shot transient signal is applied, the sweep runs only for once and the signal is displayed on the screen.

807150



## 5. MEASURING METHODS

### 5.1 Connection Method of Input Signal

The input impedance of the oscilloscope as viewed from the vertical input terminal is  $1\text{ M}\Omega$  with capacitance approximately  $30\text{ pF}$  in parallel. When the probe is used, the impedance increases to resistance  $10\text{ M}\Omega$  with capacitance approximately  $20\text{ pF}$  in parallel.

There are various methods of connection between measured signal source and oscilloscope. The most popular methods are with regular covered wires, with shielded wires, with a probe, or with a coaxial cable. Suitable one is used taking the following factors into consideration.

Output impedance of input signal source

Level and frequency of input signal

External induction noise

Distance between input signal source and oscilloscope

Types of input signals and connection methods are tabulated in the following:

Connection method Type of input signal			Covered wire	Shielded wire	Probe	Coaxial cable	Others
Low frequency	Low impedance	Near	○	○	○	○	
		Far		○		○	
	High impedance	Near		⊗	○	⊗	
		Far		⊗		⊗	
High frequency	Low impedance	Near			○	○	
		Far				○	
	High impedance	Near			○	⊗	
		Far					

(○ : Good, ⊗ : Fair)

o Connection with regular covered wires:

Set a BNC Type Adaptor (Type 942A, accessory) to the vertical input terminal and connect regular covered wires to the adaptor. This method is simple and the input signal is not attenuated. However it is susceptible to induction noise when long wires are used or when the signal source impedance is high. Another disadvantage is a large stray capacity with respect to the ground. As compared with the case the 10 : 1 probe is used, larger effects are caused by the stray capacity.

o Connection with shielded wire:

The use of a shielded wire prevents external induction noise. However, the shielded wire has as large stray capacitance as 50 pF/m ~ 100 pF/m and this method is not suitable when the signal source impedance is high or the measured signal frequency is high.

804152

o Connection with coaxial cable:

When the output impedance of the signal source is  $50\ \Omega$  or  $75\ \Omega$ , the input signal can be fed without attenuation up to high frequencies by using a coaxial cable which enables impedance matching. For impedance matching, terminate the coaxial cable with a  $50\ \Omega$  or  $75\ \Omega$  pure-resistive resistor corresponding to the characteristic impedance of the coaxial cable, as shown in Figure 11.

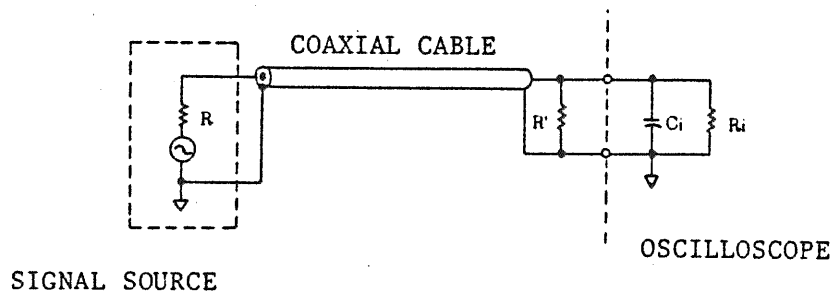

$$R = R'$$

When  $R = 50\ \Omega$ , use a  $50\ \Omega$  coaxial cable.

When  $R = 75\ \Omega$ , use a  $75\ \Omega$  coaxial cable.

Figure 11

o Connection with probe:

The 10:1 probe supplied as an accessory of the oscilloscope has a probe circuit and a probe cable shielded to prevent induction noise. The probe circuit makes up a wide-range attenuator in conjunction with the input circuit of the oscilloscope, thereby enabling a distortionless connection from DC to high frequencies. When the probe is used, although the signal level is attenuated to  $1/10$ , the input

impedance becomes very high (resistance  $10\text{ M}\Omega$ , capacitance approx.  $20\text{ pF}$ ) and the loading effect on the measured signal source is greatly reduced. Details of the probe are as follows:

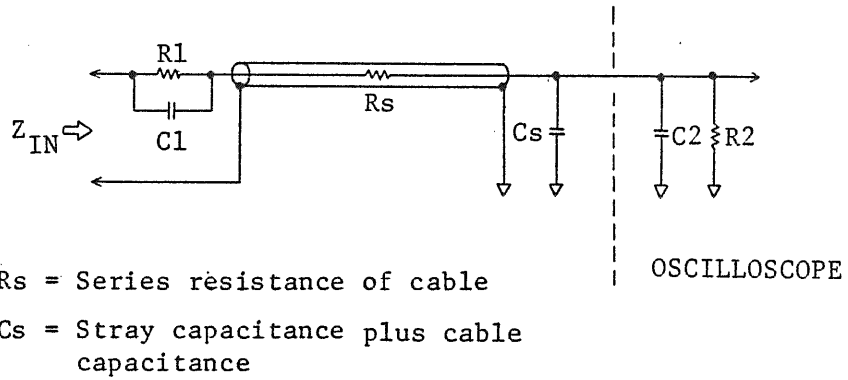

Figure 12

The probe makes up a wide-range attenuator with its resistor  $R_1$  which make up an attenuator circuit with respect to input resistor  $R_2$  of the oscilloscope and with its capacitor  $C_1$  which compensates for input capacitor  $C_2$  of the oscilloscope and stray capacitance ( $C_s$ ) of the cable.

The input impedance  $Z_{IN}$  is expressed as follows:

$$Z_{IN} = \frac{R_1 + R_2}{\omega C (R_1 + R_2) + 1}$$

$$C = \frac{C_1 \times (C_2 + C_s)}{C_1 + C_2 + C_s}$$

Attenuation factor  $A$  is expressed as follows:

$$A = \frac{R_2}{R_1 + R_2} \quad \left( = \frac{1\text{ M}\Omega}{9\text{ M}\Omega + 1\text{ M}\Omega} = \frac{1}{10} \right)$$

The values enclosed in the parentheses are for the probe supplied as an accessory of the oscilloscope.

Precautions:

- o Observe the maximum allowable input voltages mentioned in Section 3.5 "Precautions for Operation."
- o Be sure to use the ground lead wire which accompanies the probe. When used in the dual-channel mode also, be sure to use the ground lead wires for individual channels.
- o Before commencing measurement, be sure to accurately adjust the phase of the probe without fail.
- o Do not apply unreasonably large mechanical shocks or vibration to the probe. Do not sharply bend or strongly pull the probe cable.
- o The probe unit and tip are not highly heat resistant. Do not apply a soldering iron to a circuit close to the point where the probe is left hooked up.

## 5.2 Voltage Measurement

To measure an AC signal which has no DC component or to measure the AC component alone of a signal which has a DC component superimposed on the AC component, set the vertical input AC/DC selector switch ( 19 , 22 ) in the AC position. To measure a signal which has a DC component, set the switch in the DC position.

Before commencing voltage measurement, set the VARIABLE attenuator knob ( ⑮ , ⑯ ) to the CAL'D position and calibrate the sensitivity to the value indicated by the VOLTS/DIV selector ( ⑭ , ⑰ ).

Apply the signal to be measured, display the signal with an appropriate amplitude on the screen, and determine the amplitude on the graticule. (For DC voltage measurement, determine the shifted distance of the trace.) The voltage can be known as follows:

- (1) When measured signal is directly applied to input terminal:

$$\text{Voltage (V)} = \text{Deflection amplitude (DIV)} \times \text{Indication of VOLTS/DIV switch}$$

- (2) When the 10 : 1 probe is used:

$$\text{Voltage (V)} = \text{Deflection amplitude (DIV)} \times \text{Indication of VOLTS/DIV switch} \times 10$$

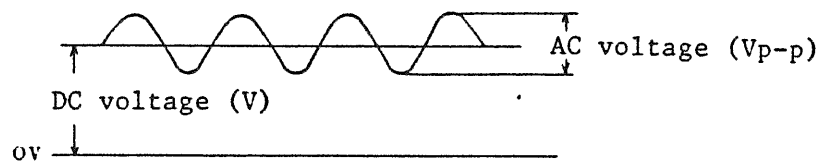

Figure 13

### 5.3 Current Measurement (Voltage Drop Method)

Connect a small-resistance resistor (R) in series in the circuit in which the current (I) to be measured flows and measure the voltage drop across the resistor with the oscilloscope. The current can be known from Ohm's law as follows:

$$I = \frac{E}{R} \quad (A)$$

The resistance should be as small as that it does not cause any change to the measured signal source.

In the above method, currents from DC to high frequencies can be measured quite accurately.

#### 5.4 Measurement of Time Interval

The time interval between any two points on the displayed waveform can be measured by setting the TIME/DIV VARIABLE knob (26) in the CAL'D position and referring to the indication of the TIME/DIV switch (25).

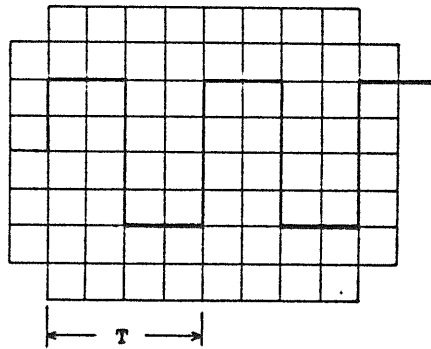

Figure 14

Time T (sec) = Indication of TIME/DIV  $\times$  Horizontal span (DIV)

When the sweep is magnified ( $5 \times \text{MAG}$  (31)), the time is 1/5 of the value determined as above.

604157

## 5.5 Frequency Measurement

- o Frequency measurement by determining time (T) per one cycle of the displayed waveform:

Time T (period) is measured as explained in Section 5.4 and the frequency is calculated by using the following formula.

$$\text{Frequency of (Hz)} = \frac{1}{\text{Period T (sec)}}$$

- o Frequency measurement with Lissajous figure (See Figures 15 and 16):

Set the MODE switch in the X-Y state so that the instrument operates as an X-Y scope. (See Section 4.3 "X-Y Operation.")

Apply to the X-axis a known frequency from a signal generator (SG) and to the Y-axis the frequency to be measured. So adjust the required controls that a pattern is displayed on the overall surface of the CRT screen. Then so adjust the frequency of the signal generator that the displayed pattern becomes stationary as shown in Figure 15. From the displayed waveform, the unknown frequency can be calculated as follows:

$$\text{Unknown frequency (Hz)} = \frac{\text{The number of crossing points over horizontal scale line}}{\text{The number of crossing points over vertical scale line}} \times \text{Frequency of signal generator (Hz)}$$



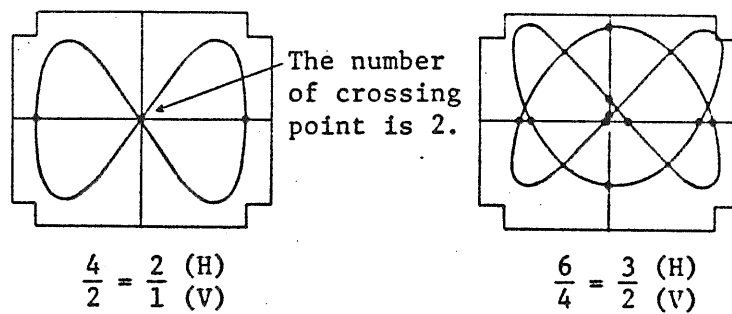

Figure 15

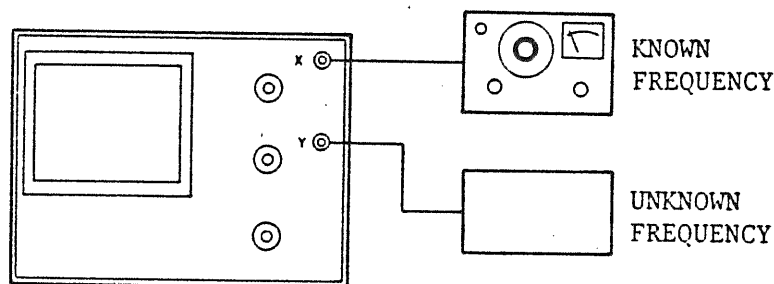

Figure 16

### 5.6 Measurement of Phase Difference

- o Measurement of phase difference with Lissajous figure  
(See Figures 16, 17 and 18):

Operate the oscilloscope in the X-Y mode as explained in the paragraph for frequency measurement, and apply two signals of the same frequency (such as stereophonic signals) to the X and Y axes so that a Lissajous figure is displayed on the CRT screen. The phase difference between the two signals can be known by measuring displayed waveform and employing the following equation:

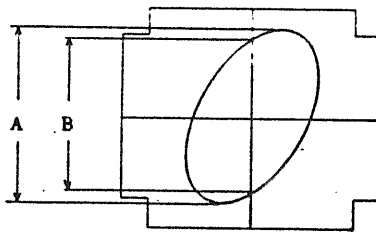

Figure 17

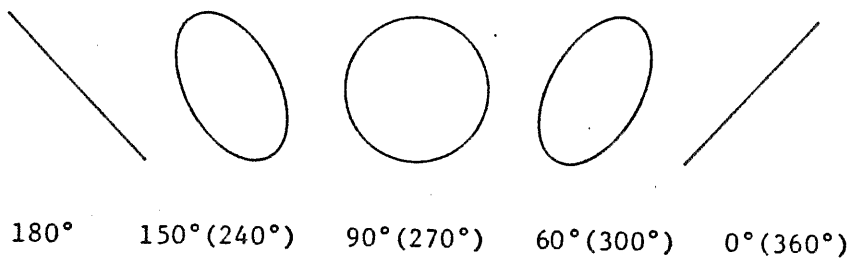

Figure 18

- o Measurement of phase difference with dual-trace operation:

Set the MODE switch in the DUAL state (10), and connect to CH1 the signal to be used for reference and to CH2 the signal to be measured. So adjust the oscilloscope that it displays signals as shown in Fig. 19.

807160

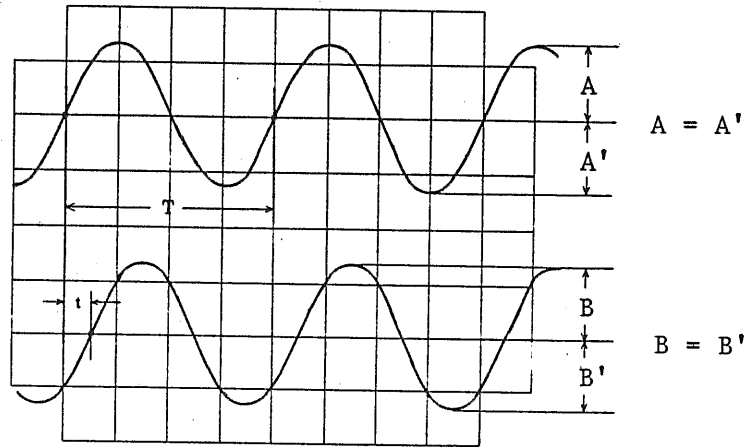

Figure 19

The phase difference ( $\theta$ ) can be calculated as follows:

$$\theta = \frac{t}{T} \times 360^\circ$$

In this dual-trace method, very small values of  $t$  can be measured. Another advantage is that the phase can be known at a glance whether it is leading or lagging.

### 5.7 Measurement of Pulse Waveform Characteristics

A theoretically ideal pulse waveform is such that the signal changes instantaneously from a certain level to another level, held in this level for a certain period, and returns instantaneously to the original level. However, actual pulse waves are distorted. Nomenclature of distortions is given in Figure 20.

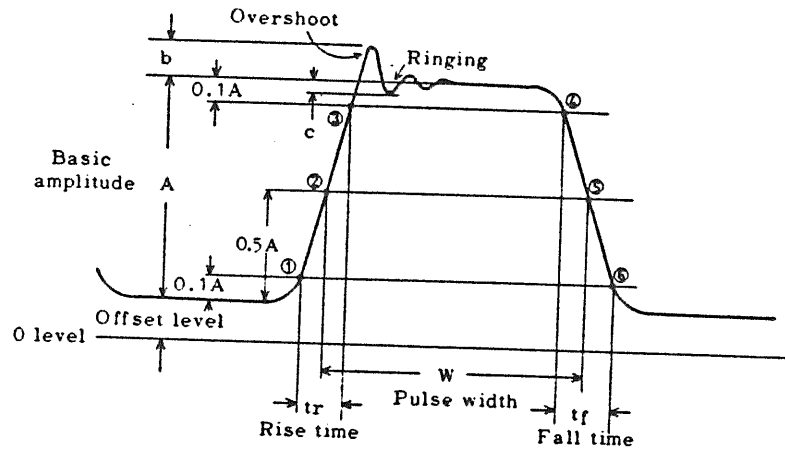

Figure 20

- Pulse amplitude: Basic amplitude (A) of pulse
- Pulse width: Time between points ② and ⑤ where signal amplitude is 50% of basic amplitude
- Rise time: Time between 10% basic amplitude point ① and 90% basic amplitude point ③
- Fall time: Time between 90% basic amplitude point ④ and 10% basic amplitude point ⑥
- Overshoot: Amplitude of the first maximum excursion beyond basic amplitude. Expressed in terms of  $b/A \times 100$  (%)
- Ringings: Oscillation which follows the first maximum excursion. Expressed in terms of  $c/A \times 100$  (%)

o Measurement of rise time:

The rise time of a pulse can be known by determining the value of  $t_r$  on the CRT screen in the method of "Time Measurement." It must be noted that  $t_r$  determined on the CRT screen includes the rise time of the oscilloscope itself. The closer the rise time of the oscilloscope ( $t_o$ ) to the rise time of the measured pulse ( $t_n$ ), the larger is the error introduced. To eliminate this error, calculation should be done as follows:

$$\text{True rise time } t_n = \sqrt{(t_r)^2 - (t_o)^2}$$

where,  $t_r$ : Rise time measured on CRT screen

$t_o$ : Rise time of oscilloscope itself  
(approx. 17.5 nsec when at 20 MHz  
band with this oscilloscope)

For example, when a pulse wave with rise time 50 nsec is measured on the CRT screen, the error is approximately 3%.

o Measurement of Sag

Pulse waveforms may have slanted-sections as shown in Figure 21, other than those distortions mentioned in Figure 20. (For example, slants are caused when the signal is amplified with an amplifier which has poor low-frequency characteristics, resulting from attenuation of the low frequency component.) The slanted section ( $d$  or  $d'$ ) is called "sag," which is calculated as follows:

$$\text{Sag} = \frac{d}{A} \quad (\text{or } \frac{d'}{A'}) \times 100 (\%)$$

804163

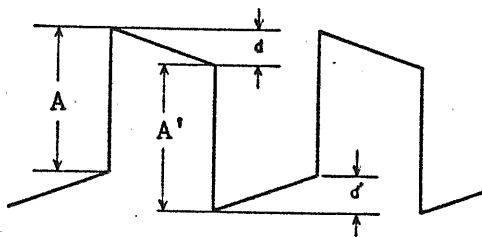

Figure 21

Note: If the AC-coupling mode is used for measurement of a low frequency pulse, sags are caused. For measurement of low frequency pulses, use always the DC-coupling mode.

## 6. CALIBRATION

### 6.1 General

The oscilloscope should be calibrated at certain time intervals. Although calibration of all performances is most recommendable, such partial calibration may serve the purpose that the time axis alone is calibrated when the time measuring accuracy is especially important or that the vertical axis alone is calibrated when the vertical sensitivity accuracy is of prime importance. After the oscilloscope has been repaired, overall calibration is repaired although it depends on the type of repair. For the repair service, contact manufacturer's agent in your area.

### 6.2 Check and Adjustment of DC Power Supply

Before calibrating the oscilloscope circuit, the DC supply voltages should be checked and adjusted. Check and adjust the +12V supply voltage first because other supply voltages also are adjusted when this adjustment is done. The supply voltages are shown in the following table. Check that the voltages are with the values shown there. The adjustment points are indicated in Figures 23 and 24. For removing the case, refer to Figure 22.

Nominal voltage	Voltage range	Check and adjustment points
+12V	+11.95V - +12.05V	TP-1, adjustment
-12V	-11.75V - -12.25V	TP-2, check
+5V	+4.75V - +5.25V	TP-3, check
+245V	+230V - +260V	TP-4, check
-1950V	-1900V - -2000V	TP-5, check

For voltage check, measure the voltage between check point and ground using a reliable digital voltmeter. The +12V supply must be especially carefully adjusted because it provides a reference for other supplies. To measure the -1950V supply of which internal impedance is high, use a voltmeter of a high input impedance (10 M $\Omega$  or over).

Because adjustments of supply voltages largely affects vertical sensitivity and horizontal sweep time, the oscilloscope must be re-calibrated as explained in the subsequent paragraphs.



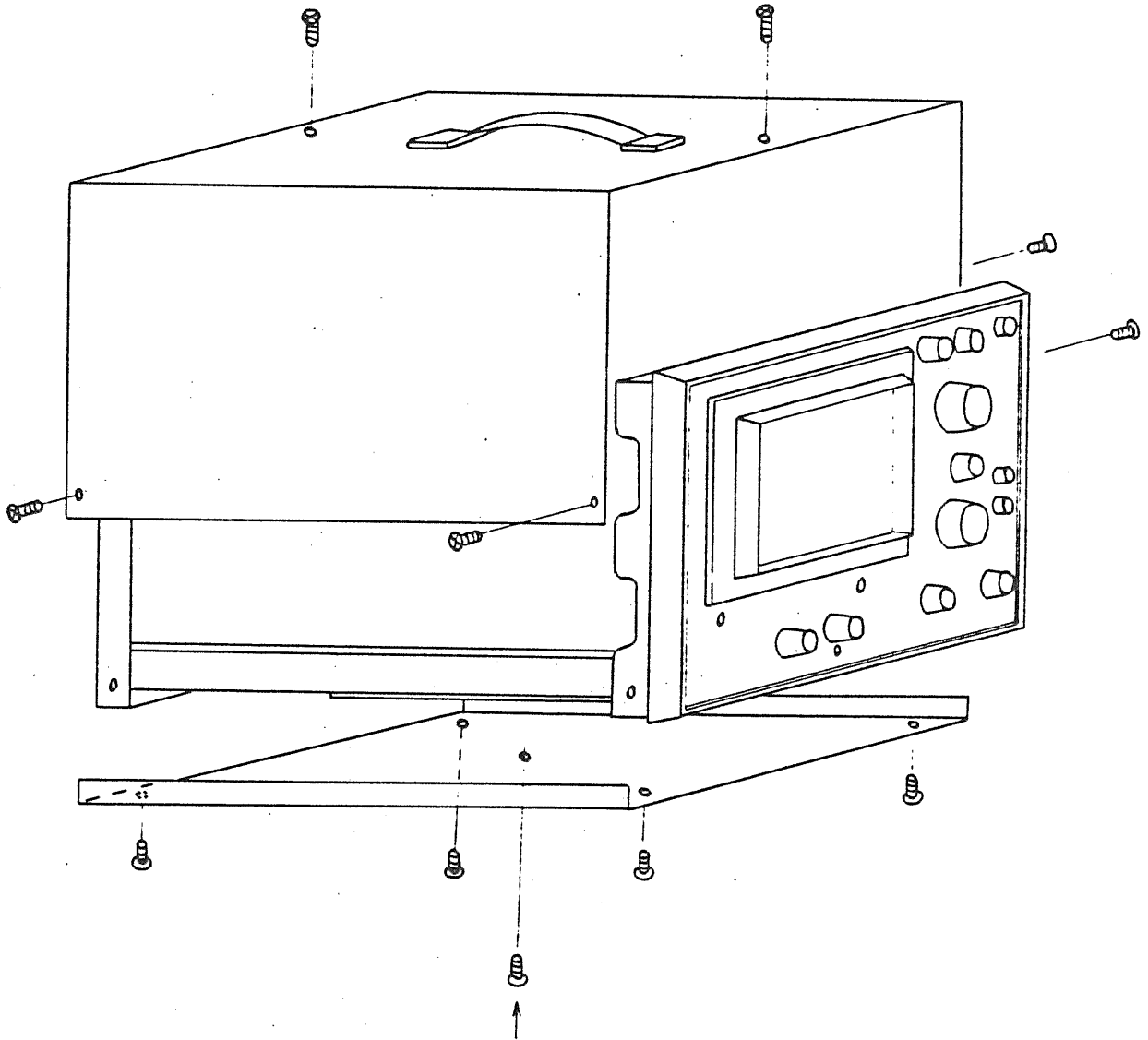

HANDLE ESPECIALLY CAREFULLY SINCE THIS  
SCREW CLAMPS THE PRINTED BOARD.

Figure 22

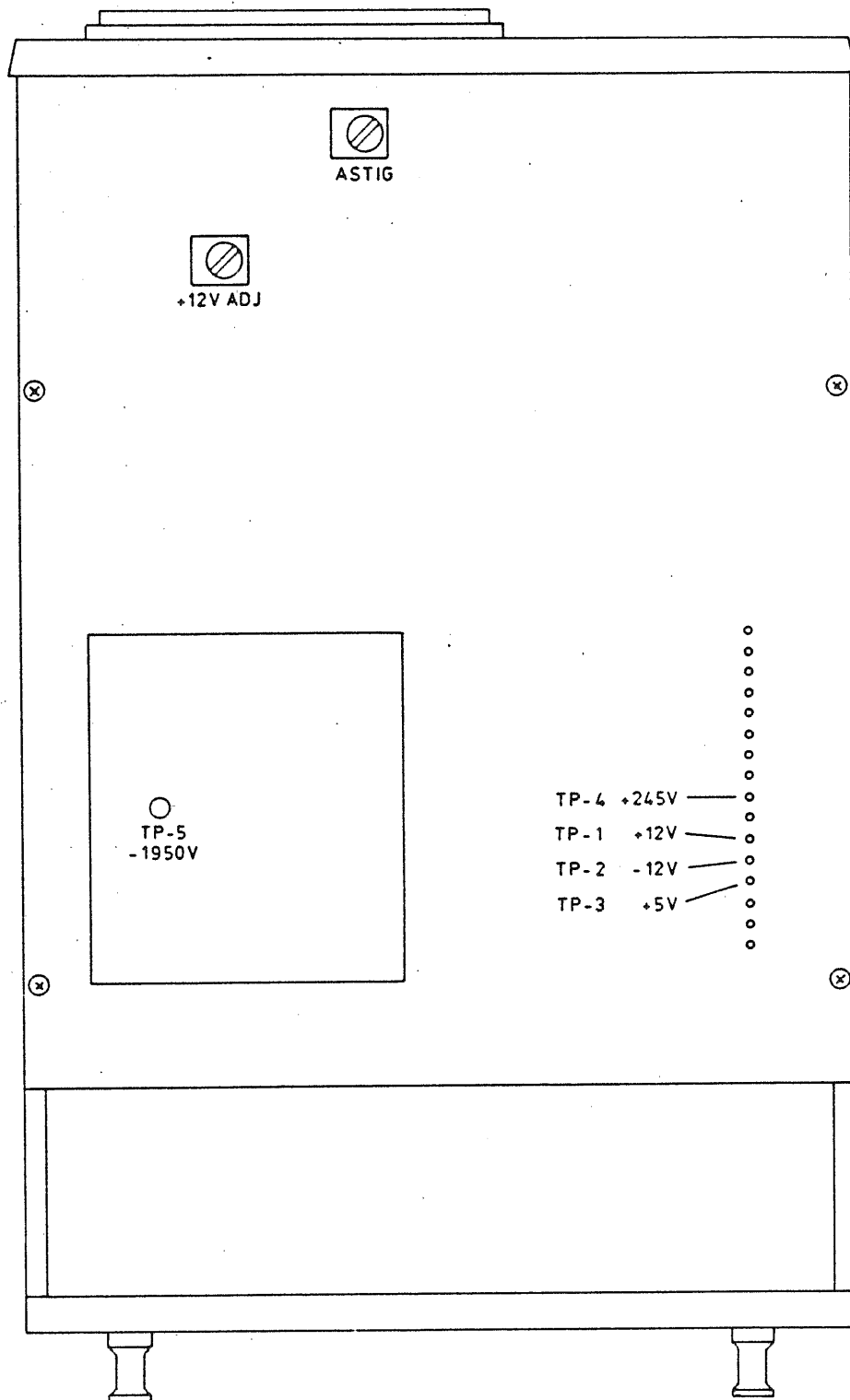

Figure 23

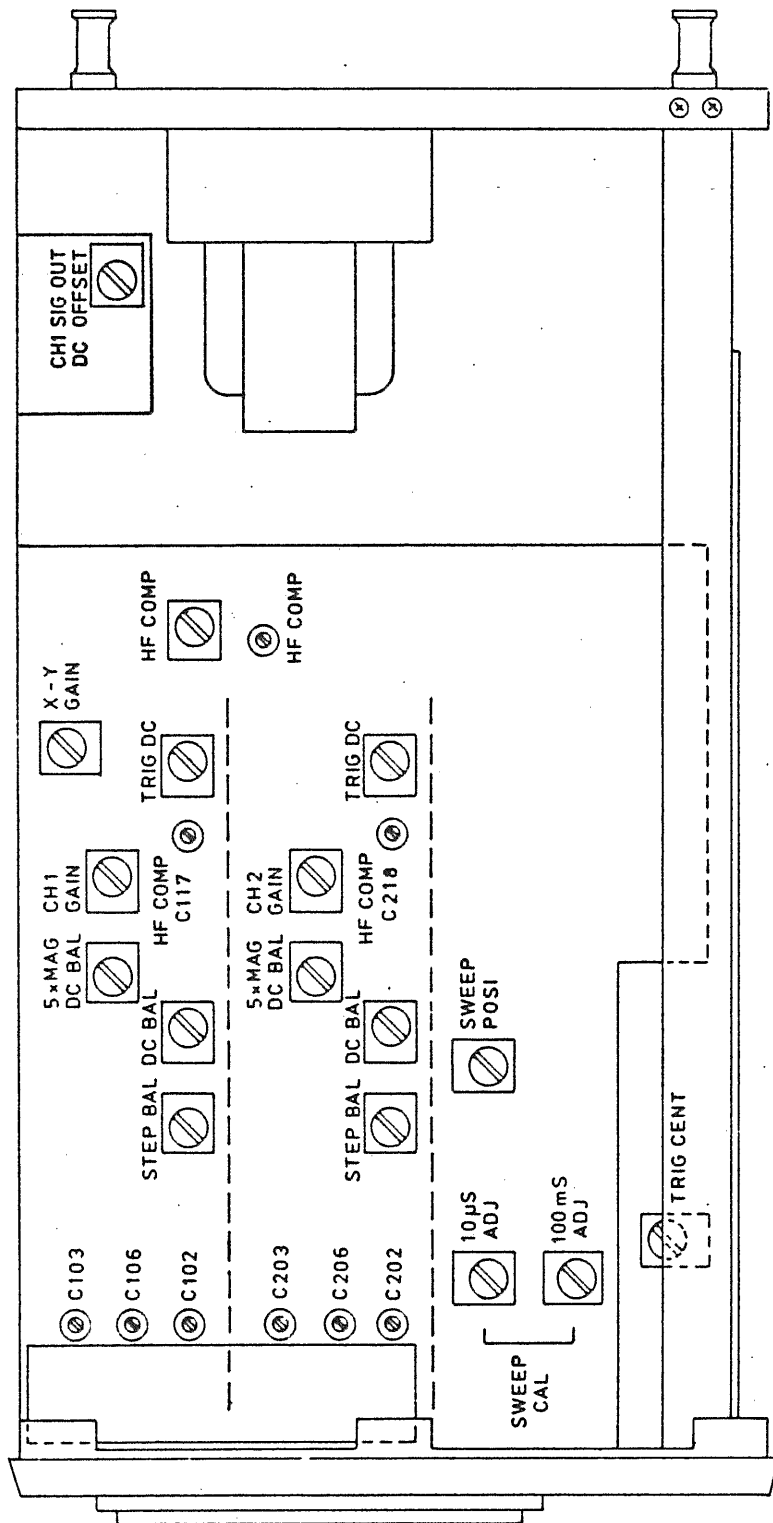

Figure 24

### 6.3 Adjustment of Vertical Axis

#### o Adjustment of STEP BAL

This control is for minimizing the shift of the trace when the VOLTS/DIV switch is turned.

- (1) Set the    GND switch in the    GND state and display the trace on the CRT screen.
- (2) Turning the VOLTS/DIV switch between 0.2V and 0.5V positions, so adjust the STEP BAL control (see Figure 24) that the shift of the trace becomes minimum.

#### o Adjustment of DC BAL

This control is for minimizing the shift of the trace when the VARIABLE knob is turned.

- (1) Set the    GND switch in the    GND state and display the trace on the CRT screen.
- (2) Turning the VARIABLE knob, so adjust the DC BAL control that the shift of the trace becomes minimum. (See Figure 24)

#### o Adjustment of CH1 SIGNAL OUT DC OFFSET:

After adjusting the STEP BAL and DC BAL controls, so adjust the CH1 OFFSET control (R301) that the DC component of the output signal is balanced out.

#### o Calibration of sensitivity

This control is for adjusting the vertical gain so that the vertical deflection amplitude conforms with the value indicated by the VOLTS/DIV switch. For calibration, use a pulse

804170

generator which provides a square-wave output signal with a voltage setting accuracy of 0.5% or better at a frequency of 1 kHz.

- (1) Set the pulse generator output at 8 times of the voltage ( $V_{p-p}$ ) indicated by the VOLTS/DIV switch and apply this signal to the vertical INPUT terminal.
- (2) Set the VARIABLE knob in the CAL'D position and the VOLTS/DIV switch in the 5 mV position, and so adjust the GAIN ADJ control (Figure 24) that the deflection amplitude on the CRT screen becomes as set in (1) above.

When the above adjustment is made, other ranges also are automatically calibrated with an accuracy of  $\pm 5\%$  or better.

- o Adjustment of input attenuator (input capacitance adjustment and phase compensation)

If the phase compensation of the 1/100 input attenuator has been disturbed, the oscilloscope does not present the normal frequency response and the displayed waveform is distorted. If the input capacitance has been disturbed, the procedure of "Calibration of Probe" is required to be performed each time the range is changed. (Refer to Section 5.1 "Connection Method of Input Signal", Item "Connection with probe.")

To adjust the phase characteristics, use a pulse generator which can provide a square wave which has no sag or overshoots or other distortions and which has a rise time of faster than 1  $\mu$ sec. Display this signal with an amplitude of 4 DIV at each range, and so adjust the phase compensation capacitor that the displayed square wave signal becomes the best waveform. For this adjustment, use a pulse signal of repetition frequency of approximately 1 kHz.

To adjust the input capacitance adjustment, connect a low-range C-meter to the input terminal and so adjust the input capacitance compensation capacitor that the input capacitance at each range becomes  $30 \text{ pF} \pm 2 \text{ pF}$ .

For the above adjustment, set the oscilloscope in the operating state. The capacitors for respective ranges are shown in the following table.

Range	CH1		CH2	
	Adjusting capacitor		Adjusting capacitor	
	Input capacitance	Phase compensation	Input capacitance	Phase compensation
5 mV	C102	-	C202	-
0.5 V	C106	C103	C206	C203

The ranges enclosed in the parentheses require no adjustment. They require check only.

- o Adjustment of high frequency characteristics of vertical amplifier

To adjust the high frequency response of the amplifier, use a quality pulse wave of rise time faster than 10 nsec and repetition frequency 500 kHz.

- (1) Apply the above pulse wave signal to the input terminal, set the VOLTS/DIV switch in the 5 mV position and the TIME/DIV switch in the 0.2  $\mu\text{sec}$  position, and so adjust the signal generator output that a deflection amplitude of 4 DIV is obtained on the CRT screen.

804172

- (2) So adjust the HF COMP circuit (C302, R306) of the output stage that the leading edges of the square wave become flat.
- (3) So adjust the HF COMP trimmer capacitor (C117 or C218) of the preamplifier stage that the leading edges become flat.

Repeat the above procedure several times so that an ideal waveform is obtained.

Adjustment of HF COMP (C302, R306) of output stage

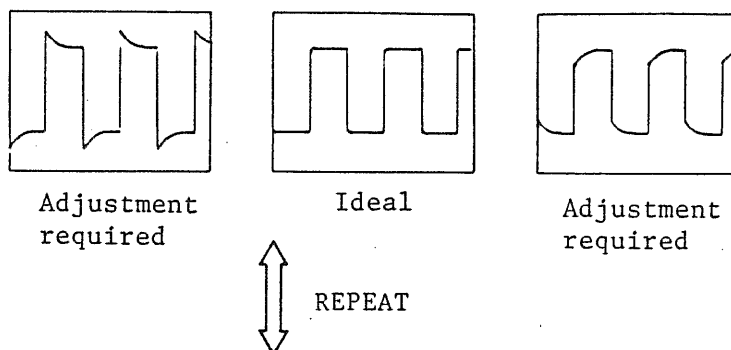

Adjustment of HF COMP (C117, C218) of preamplifier

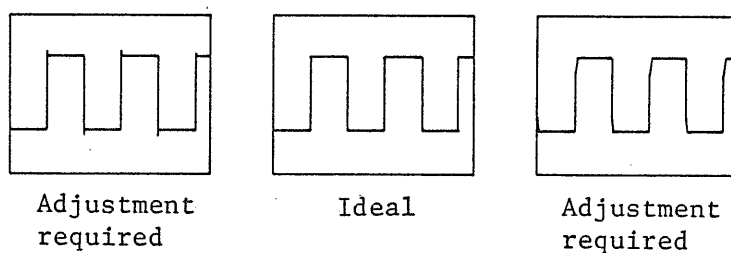

By the above adjustment, the square wave characteristics also adjusted.

#### 6.4 Adjustment of Time Axis

- o Trigger adjustment
  
- o Adjustment of trigger center (TRIG CENTER)

Set the TRIGGERING selector in the AC state and so adjust the TRIG CENTER control that the trigger point is set at the center of the deflection amplitude when the white dot mark of the LEVEL knob is set in the upright position (noon high position).

- (1) Apply a sine wave of about 1 kHz to the vertical input terminal and display the signal with a full deflection amplitude on the CRT screen.
  
- (2) Set the oscilloscope in the INT TRIG and AC-coupling mode. Set the white mark of the LEVEL knob in the upright position. Under this state, so adjust the TRIG CENTER control that the triggering point is set at the center of the deflection amplitude.

- o Adjustment of TRIG DC

- (1) Apply a sine wave of approximately 1 kHz to the vertical input terminal and display the signal with a full deflection amplitude on the CRT screen.
  
- (2) Switching between AC-coupling and DC-coupling under the INT TRIG mode, so adjust the TRIG DC control that the triggering points of both coupling modes are overlapped.

804174



o Adjustment of Time Axis

This adjustment is for calibrating the sweep time at the value indicated by the TIME/DIV switch. For this adjustment, use time marker signals of accurate time intervals of 10  $\mu$ sec and 10 msec or use signals of accurate frequencies of 100 kHz and 100 Hz.

- (1) Set the TIME/DIV switch in the 10  $\mu$ sec position and apply a time marker signal of 10  $\mu$ sec or a sine wave signal of 100 kHz to the vertical input terminal of the oscilloscope. Deflect the signal with an appropriate amplitude on the CRT screen by adjusting the input signal level or oscilloscope gain.
- (2) So adjust the 10  $\mu$ S SWEEP CAL control (see Figure 24) that the displayed waveform conforms with graticule divisions.
- (3) Set the TIME/DIV switch in the 10 msec position and apply a time marker signal of 10 msec or a sine wave signal of 100 Hz to the vertical input terminal of the oscilloscope.
- (4) So adjust the 10 mS ADJ control (see Figure 24) that the waveform conforms with graticule scale divisions.

When the above calibration is complete, the sweep speeds of the remaining ranges also are calibrated at an accuracy of  $\pm 5\%$ . The sweep time for 5  $\times$  MAG operation also is calibrated.

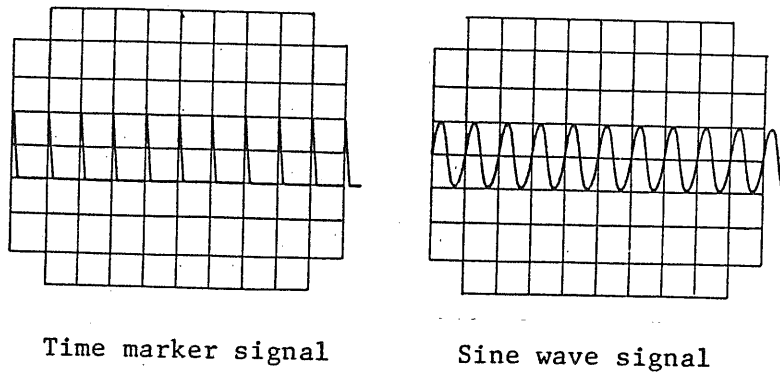

Figure 25

o Adjustment of SWEEP POSITION control

- (1) So set the horizontal POSITION knob ( 31 ) in Figure 1) that its white dot mark is in the upright position (noon high position).
- (2) Set the TIME/DIV switch in the 1 msec/DIV position.
- (3) So adjust the SWEEP POSITION control (semi-fixed resistor, see Figure 24) that the start position of the sweep is brought to the left-hand end of the graticule.

6.5 Adjustment of Horizontal Axis (X-axis)

This procedure is for calibrating the X-axis sensitivity when in the X-Y operation.

- o X-axis sensitivity calibration when in X-Y operation

Although the vertical sensitivities of CH1 and CH2 are calibrated in Section 6.3, they are not calibrated for the X-Y operation. For the X-Y operation, the X-axis sensitivity is required to be calibrated while Y-axis is not required to be calibrated because its vertical sensitivity has already been calibrated. For calibrating the X-axis sensitivity, use the signal generator which has been used in Section 6.3 "Adjustment of Vertical Axis."

- (1) Set the signal generator at a voltage ( $V_{p-p}$ ) of 10 times of the value indicated by the VOLTS/DIV switch. Apply this voltage signal to CH1.
- (2) So adjust the X-Y GAIN (Semi-fixed resistor, see Figure 24) that the displayed signal amplitude is aligned with both ends of the graticule.

## 6.6 Calibration of Probe

As explained previously, the probe makes up a kind of wide-range attenuator. Unless phase compensation is properly done, the displayed waveform is distorted causing measurement errors. Therefore, the probe must be properly calibrated before use. For probe calibration, use the signal of the calibration voltage terminal (4) of the front panel.

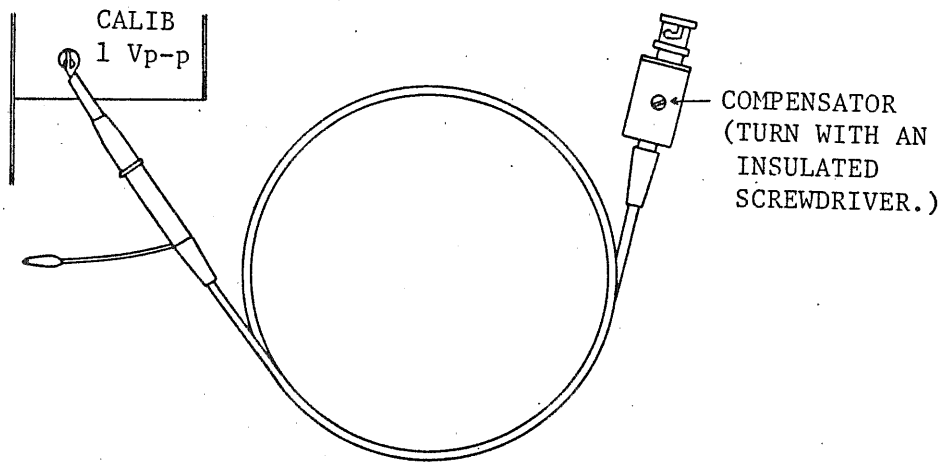

Figure 26

Connect the probe connector to the INPUT terminal of CH1 or CH2 and set VOLTS/DIV switch in the 20 mV position. Connect the probe tip to the calibration voltage output terminal and so adjust the COMPENSATOR control with an insulated screwdriver that an ideal waveform as illustrated below is obtained.

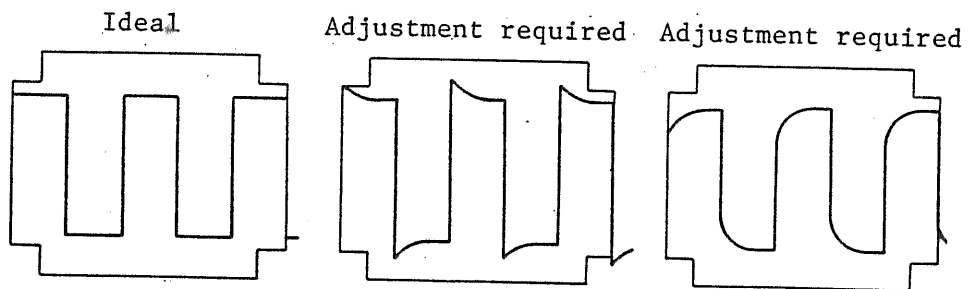

Figure 27

804178

\* Use of Illuminatable External Graticule

The CRT of this oscilloscope has an internally-printed graticule (parallaxless). However, this graticule cannot be illuminated for photographing.

If a graticule is required to be photographed together with the waveform displayed on the CRT screen, this can be done by installing the illuminatable external graticule (an accessory) before the blue filter on the CRT screen as illustrated below:

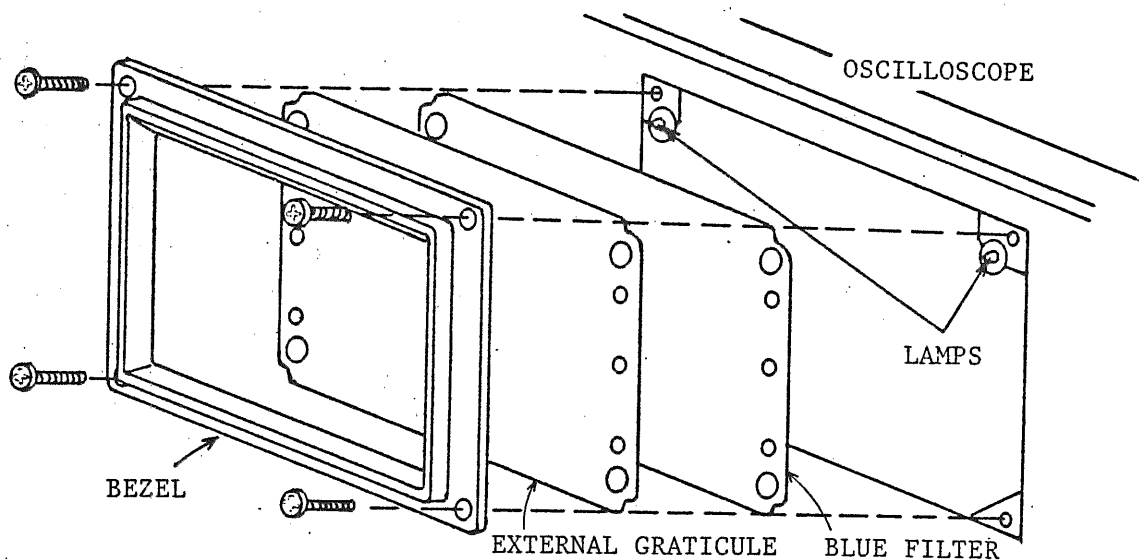

So place the external graticule that its printed side is positioned toward the CRT and align its guide holes with the guide pins of the bezel.

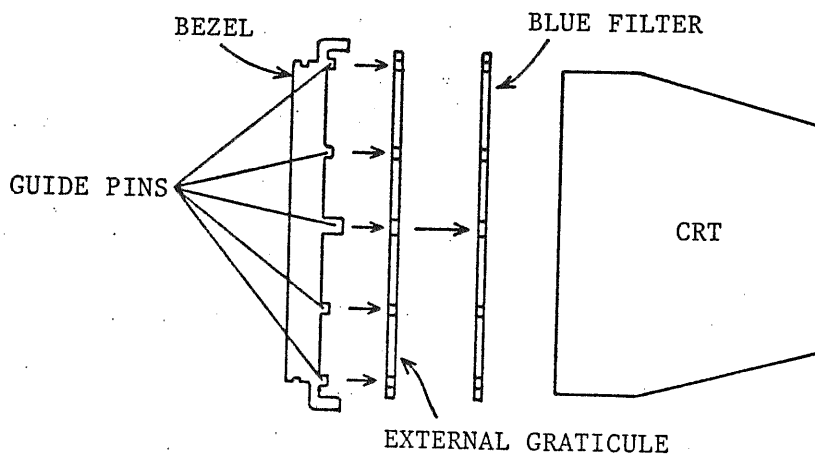

The external graticule and blue filter can be clamped with the bezel, aligning its guide pins with the guide holes of the graticule and filter.

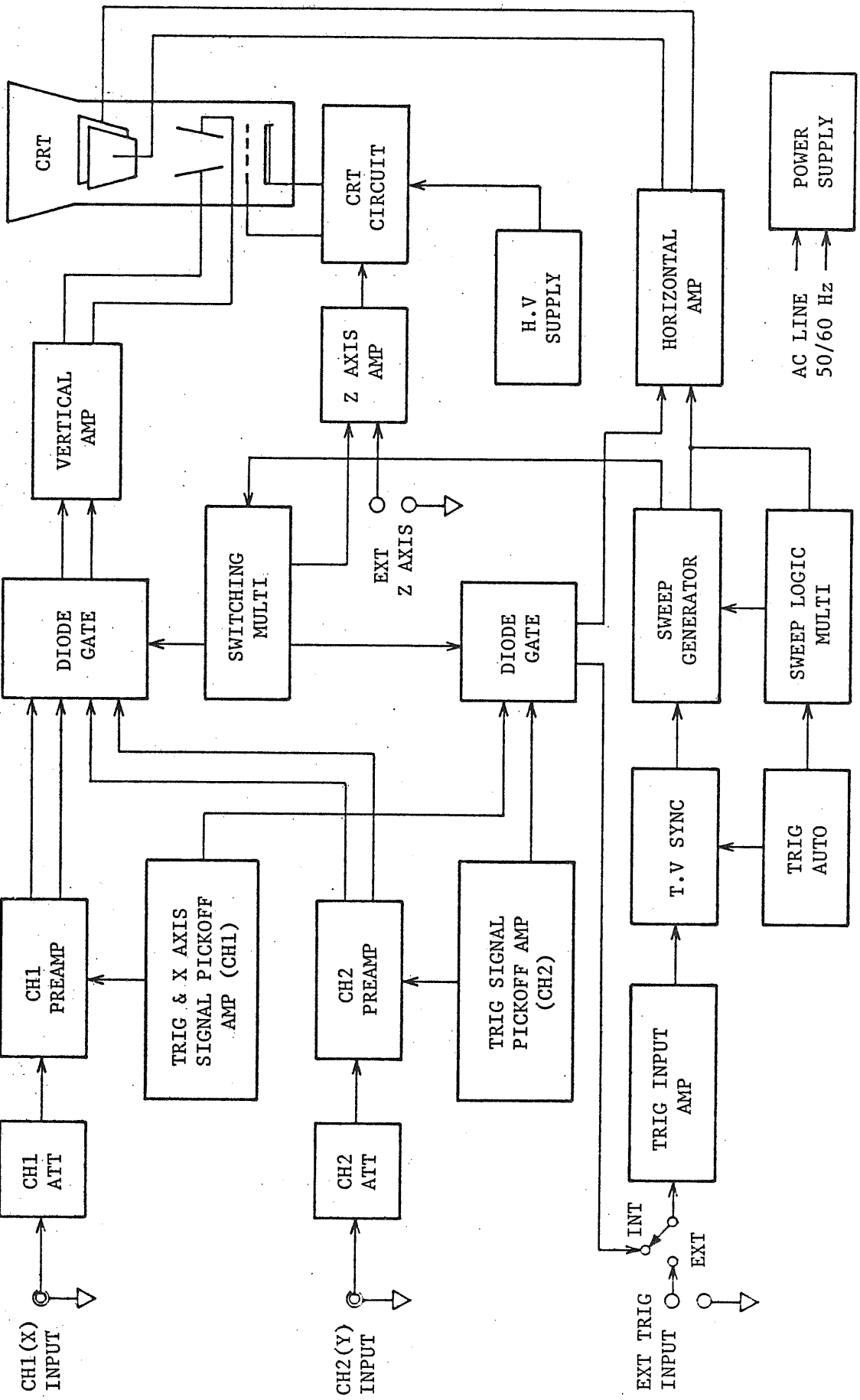

Block Diagram